



J I E D R I V E



JRT Gearmotor Operating Instructions

JIE INTELLIGENT DRIVE SOLUTIONS PROVIDER





Contents



1 Important Notes.....	5
------------------------	---

2 Safety Noets	6
----------------------	---



3 Installation	7
----------------------	---

3.1 Prerequisites for assembly.....	7
-------------------------------------	---

3.2 Work for assembly	7
-----------------------------	---

3.3 Installing the gear unit	7
------------------------------------	---



4 Mechanical Installation.....	9
--------------------------------	---

4.1 Required tools/aids	9
-------------------------------	---

4.2 Gear unit with solid shaft	10
--------------------------------------	----

4.3 Torque arms for mounted gear units	12
--	----

4.4 AM adapter coupling	19
-------------------------------	----

4.5 AQ adapter coupling	21
-------------------------------	----

4.6 AD input shaft assembly	22
-----------------------------------	----



5 Startup.....	22
----------------	----

5.1 Startup of helical-worm gear units	22
--	----



6 Inspection/ Maintenance	22
------------------------------------	----

6.1 Inspection and maintenance intervals.....	22
---	----

6.2 Lubricant change intervals	23
--------------------------------------	----

6.3 Inspection and maintenance of the gear unit	23
---	----



7 Malfunctions	24
----------------------	----



8 Mounting Positions	25
----------------------------	----

8.1 General information on mounting positions	25
---	----

8.2 Important order information.....	26
--------------------------------------	----



9 Lubricants	28
--------------------	----

9.1 Lubricant fill quantities	28
-------------------------------------	----

9.2 Lubricant used regularly	33
------------------------------------	----

1 Important Notes

Safety and warning instructions

Always follow the safety and warning instructions in this publication!



Electrical hazard
Possible consequences: Severe or fatal injuries



Hazard
Possible consequences: Severe or fatal injuries



Hazardous situation
Possible consequences: Slight or minor injuries



Harmful situation
Possible consequences: Damage to the drive and the environment



Tips and useful information



You must adhere to the operating instructions to ensure

- Trouble-free operation
- Fulfillment of any rights claim under guarantee

Consequently, read the operating instruction before you start to working with the gear units!

The operating instructions contain important information about servicing. Therefore, Keep the operating instruction close to the gear units.

Waste Disposal

Please follow the latest instructions: Dispose of the following materials in accordance with the regulations in force:



- **Steel scrap:**
Housing parts Gear Shafts
Anti-friction bearing Gray-cast iron (if there is no special collection)
- **Parts of the worm gears are made of non-ferrous metals. Dispose of the worm gears as appropriate.**
- **Collect waste oil and dispose of it correctly.**



- **Adjust the lubricant fill volume and position of the breather valve**
- **Accordingly in the event of a change of mounting position(see Sec "Lubricants" and "Mounting positions")**
- **Follow the instructions in Sec. "Mechanical installation"/ "Installing the gear units"!**

2 Safety Notes

Preface

The following safety notes are primarily concerned with the use of gear units. If using gearmotors, please also refer to the safety notes for motors in the relevant operating instructions.

Please also consider the supplementary safety notes in the individual sections of these operating instructions.

General information

During and after operation, gearmotors, gear units and motors have:

- Live parts
- Moving parts
- Hot surfaces (may be the case)

Only qualified personnel may carry out the following work:

- Transportation
- Putting into storage
- Installation / assembly
- Connection
- Startup
- Maintenance
- Servicing

The following information and documents must be observed during these processes:

- Relevant operating instructions and wiring diagrams
- Warning and safety signs on the gear unit / gearmotor
- System-specific regulations and requirements
- National / regional regulations governing safety and the prevention of accidents

Serious injuries and property damage may result from:

- Improper use
- Incorrect installation or operation
- Unauthorized removal of necessary protection covers or the housing

Designated use

Gearmotors / gear units from JIE are intended for industrial systems. They correspond to the applicable standards and regulations.

Technical data and information about the permitted conditions can be found on the nameplate and in the documentation.

It is essential that you follow all the instructions!

Transportation

Inspect the shipment for any damage that may have occurred in transit as soon as you receive the delivery. Inform the shipping company immediately. It may be that you are not permitted to start up the drive due to the damage.

Use suitable sufficiently rated handling equipment if necessary. Remove any transportation fixtures prior to startup.

Installation / Assembly

Observe the instructions in the sections "Installation" and "Assembly / Rem-oval"

Startup / Operation

Check that direction of rotation is correct decoupled status. Listen out for unusual grinding noises as the shaft rotates.

Secure the shaft keys for test mode without drive components. Do not render monitoring and protection equipment inoperative even for test mode.

Switch off the gearmotor if in doubt whenever changes occur in relation to normal operation (e.g. increased temperature, noise, vibration). Determine the cause; contact JIE-ASIDRIVE if necessary.

Inspection / Maintenance

Follow the instructions in the section "Inspection and Maintenance"

3 Prerequisites for assembly

3.1 Check that the following conditions have been met:

- The data on the nameplate of the gearmotor matches the voltage supply system.
- The drive has not been damaged during transportation or storage
- Ensure that the following requirements have been met:

For standard gear units:

Ambient temperature according to the lubricant table in Sec. "Lubricants"(see standard)

The drive must not be assembled in the following ambient conditions:

- Potentially explosive atmosphere
- Oil
- Acids
- Gas
- Vapors
- Radiation

For special versions:

The drive configured in accordance with the ambient conditions.

For helical-worm gear units:

No large external mass moments of inertia which could exert a retrodriving load on the gear unit.

3.2 You must clean the output shafts and flange surfaces thoroughly to ensure they are free of anti-corrosion agents, contamination or similar. Use a commercially available solvent. Do not let the solvent come into contact with the sealing lips of the oil seals —danger of damage to the material!

When the drive is installed in abrasive ambient conditions, protect the output end oil seals against wear.

3.3 Installing the gear unit

The gear unit or gearmotor is only allowed in the specified mounting position.

The oil checking and drain screws and the breather valves must be freely accessible!

At the same time, also check that the oil fill is as specified for the mounting position. The gear units are filled with the required oil volume at the factory. There may be slight deviations at the oil level plug as a result of the mounting position, which are permitted within the manufacturing tolerances.

Use plastic inserts (2–3mm) if there is a risk of electrochemical corrosion between the gear unit and the driven machine. The material used must have an electrical bleeder resistor $< 10^6 \Omega$. Electrochemical corrosion can occur between various metals, for example, cast iron and high-grade steel. Also install the bolts with plastic washers! Ground the housing additionally use the grounding bolts on the motor.

Installation in Damp locations Or in the open

Drives are supplied in corrosion-resistant versions for use in damp areas or in the open air. Repair any damage to the paintwork

Gear unit venting

JRTR17, JRTR27 in mounting positions M1, M3, M5 and M6 have no breather plug.

JIE supplies all other gear units with the breather valve installed and activated according to the particular mounting position.

Exceptions

1. JIE supplies the following gear units with a screw plug on the vent hole provided:
 - Gear units for extended storage
 - Pivoted mounting positions, if possible
 - Gear units for mounting on a slantThe breather valve is located in the motor terminal box. Before start-up, you must replace the highest screw plug with the breather valve supplied.
2. JIE supplies a breather valve in a plastic bag for gear head units requiring venting on the input end.

Activating the breather valve

1. Breather valve with transport fixture

2. Remove the transport fixture

3. Breather valve activated

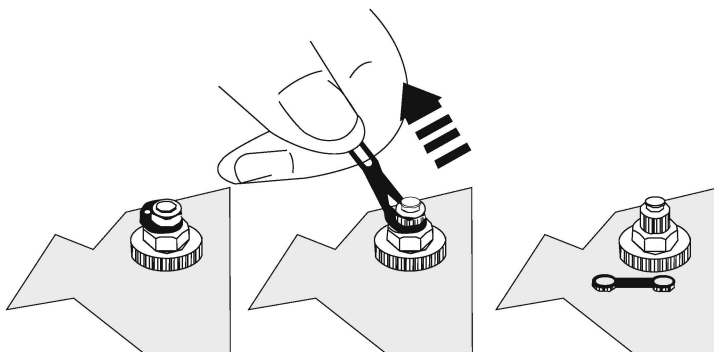

Pic.1 Activating the breather valve

Painting the gear unit

If you paint or respray the drive, ensure that you cover the breather valve and oil seals carefully. Remove the strips of tape after completing the painting work.

4 Mechanical Installation

4.1 Required tools / aids

- Set of spanners
- Torque wrench (for shrink discs, AQH motor adapter and input shaft assem
-bly with centering shoulder
- Mounting device
- Shims and distance rings if necessary
- Fixing devices for input and output elements
- Lubricant
- Bolt adhesive

Installation tolerances

Tab1

Shaft end	Flanges
Diameter tolerance accordance with DIN 748 <ul style="list-style-type: none"> • ISO k6 for solid shafts with $\phi \leq 50\text{mm}$ • ISO m6 for solid shafts with $\phi > 50\text{mm}$ • ISOH7 for hollow shafts Center bore in accordance with DIN 332, shape DR	Centering shoulder tolerance in accordance with DIN 42948 <ul style="list-style-type: none"> • ISOj6 with $b1 \leq \text{mm}$ • ISOh6 with $b2 > 230\text{mm}$

4.2 Gear unit with solid shaft Installing input and output elements

The following figure shows a mounting device for installing couplings or hubs on gear unit or motor shaft ends. It may be possible to dispense with the thrust bearing on the mounting device.

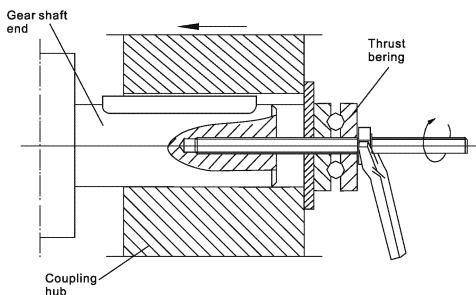

Avoid impermissibly high overhung loads: Install the gear or chain sprocket according to figure B.

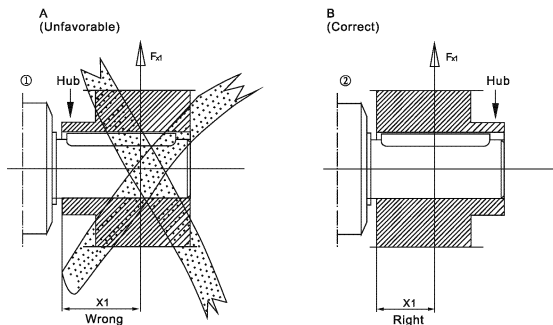

- Only use a mounting device for installing input and elements. Use the center bore and the thread on shaft end for positioning.
- **Never drive belt pulleys, couplings, pinions, etc. onto the shaft end by hitting them with a hammer. This will damage the bearings, housing and the shaft!**
- **In the case of belt pulleys, make sure the belt is tensioned correctly in accordance with the manufacturer's instructions.**
- Power transmission elements should be balanced after fitting and must not give rise to any impermissible radial or axial forces

Note:

Assembly is easier if you first apply lubricant to the output element or heat it up briefly (to 80~100° C)

Installing couplings

Couplings must be mounted and balanced according to the information provided by the coupling manufacturer:

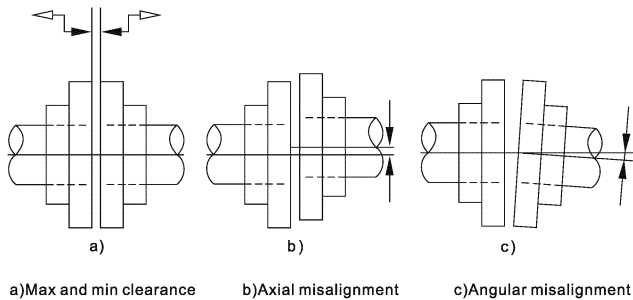

Input and output elements such as belt pulleys, couplings, etc. must be protected against contact!

4.3 Torque arms for mounted gear units

Do not place torque arms under strain during installation!

**Parallel shaft
Helical-bevel gear units**

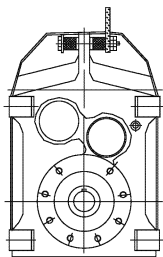

Helical gear units

- Bush with bearings on both ends → (1)
- Install connection end B as a mirror image of A

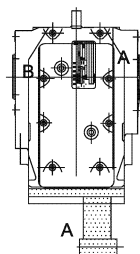
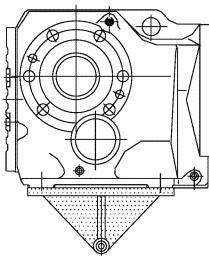

Helical-worm gear units

- Bush with bearings on both ends → (1)

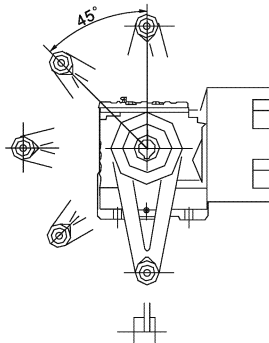
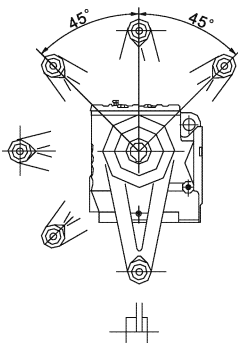

Pic. 5 : Torque arm for helical-worm gear units

Mounted gear unit with keyway or splined hollow shaft

Installation notes

1. Apply Anti-seize paste

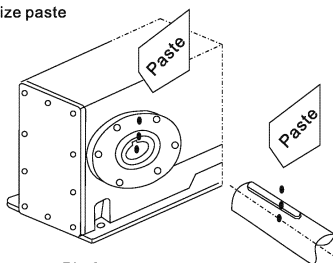

Pic. 6

2. Distribute the Anti-seize paste carefully

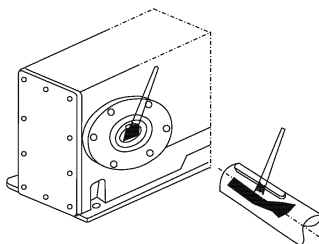

Pic. 7

3. Install the shaft and secure it axially
(mounting is facilitated by using a mounting device)

3A: Mounting with standard scope of delivery

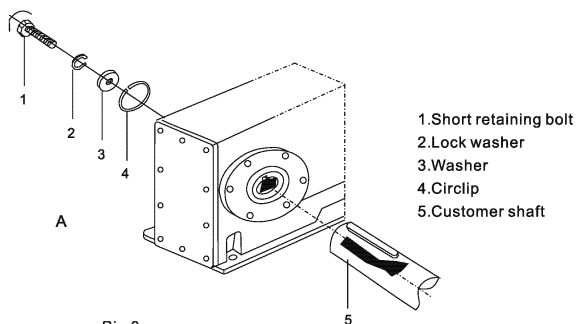

Pic. 8

- 1.Short retaining bolt
- 2.Lock washer
- 3.Washer
- 4.Circlip
- 5.Customer shaft

3B: Assembly with JIE assembly / disassembly kit

Customer's shaft with contact shoulder

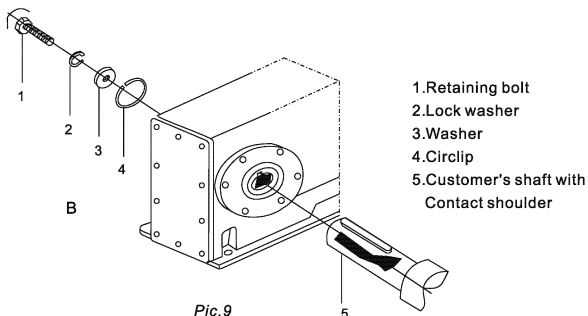

3C: Assembly with JIE assembly / disassembly kit

Customer's shaft without contact shoulder

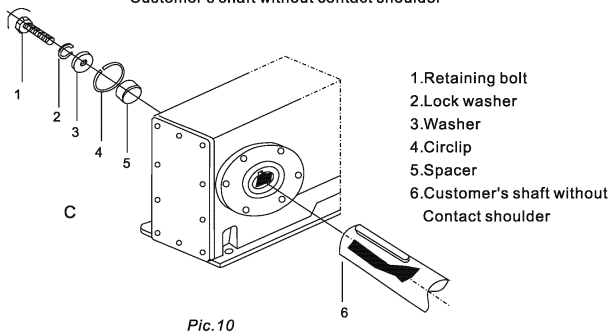

4. Tighten the retaining bolt to the appropriate torque (see table 2)

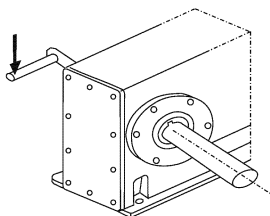

Table 2:

Bolt	Tightening torque (Nm)
M5	5
M6	8
M10/12	20
M16	40
M20	80
M24	200



Note:

To avoid contact corrosion, we recommend that the customer's shaft should additionally be recessed between the two contact surfaces!

Removal notes

This description is only applicable when the gear unit was assembled using the installation / removal kit from JIE

1. Loosen the retaining bolt 1 .
2. Remove parts 2 to 4 and, if fitted, spacer 5.

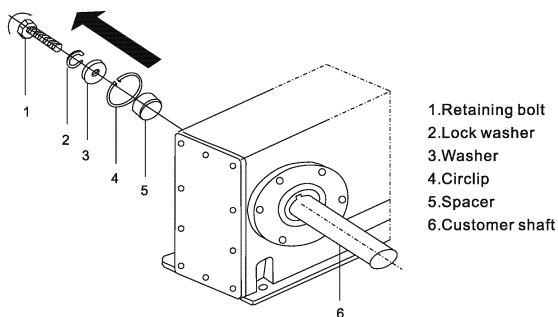

Pic.12

3. Insert the forcing washer 8 and the fixed nut 7 from the JIE installation / removal kit between the customer's shaft 6 and the circlip 4.
4. Re-insert the circlip 4.
5. Screw the retaining bolt 1 back in. Now you can force the gear unit off the Shaft by tightening the bol

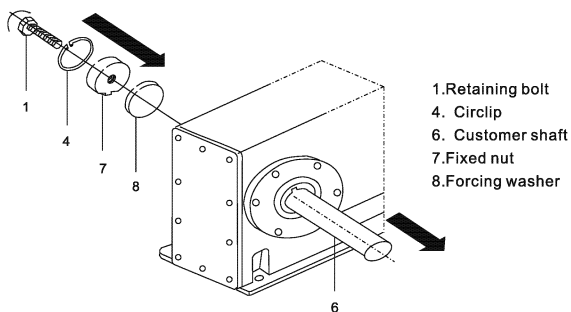

Pic.13

JIE installation removal kit

JIE installation /removal kit can be ordered under the following part number.

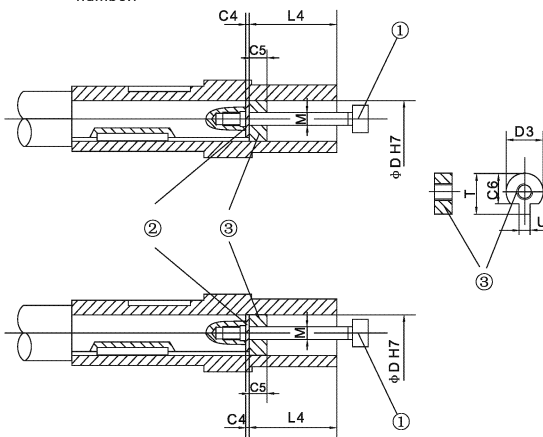

Pic.14 JIE installation / removal kit

- 1 Retaining bolt
- 2 Fixed nut for disassembly
- 3 Forcing washer

Table 3

Type	D ^{H7} [mm]	M ¹⁾	C4 [mm]	C5 [mm]	C6 [mm]	U ^{-0.5} [mm]	T ^{-0.5} [mm]	D3 ^{-0.5} [mm]	L4 [mm]
JRTSA..47	25	M10	5	10	20	7.5	28	24.7	35
JRTFA..37, KA..37, SA..47, SA..57,	30	M10	5	10	25	7.5	33	29.7	35
JRTFA..47, KA..47, SA..57	35	M12	5	12	29	9.5	38	34.7	45
JRTFA..57, KA..57, FA..47, KA..67, SA..67	40	M16	5	12	34	11.5	41.9	39.7	50
JRTSA..67	45	M16	5	12	38.5	13.5	48.5	44.7	50
JRTFA..77, KA..77, SA..77	50	M16	5	12	43.5	13.5	53.5	49.7	50
JRTFA..87, KA..87, SA..77, SA..87,	60	M20	5	16	56	17.5	64	59.7	60
JRTFA..97, KA..97, SA..87, SA..97,	70	M20	5	16	65.5	19.5	74.5	69.7	60
JRTFA..107, KA..107, FA..97	90	M24	5	20	80	24.5	95	89.7	70
JRTFA..127, KA..127	100	M24	5	20	89	27.5	106	99.7	70
JRTFA..157, KA..157	120	M24	5	20	107	31	127	119.7	70

1) setscrew

Mounted gear units with shrink disc Installation notes

• **Do not tighten the locking bolts unless the shaft is installed the hollow shaft could become deformed!**

1. Carefully degrease the hollow shaft hole and the input shaft

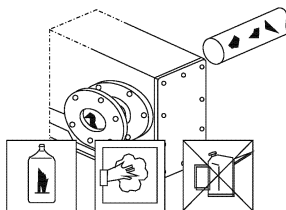

Pic.15

2. Hollow shaft / input shaft after degreasing

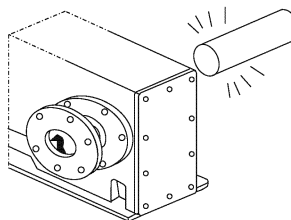

pic.16

3. Apply Anti-seize paste to the input shaft¹⁾ in the area of the bushing.

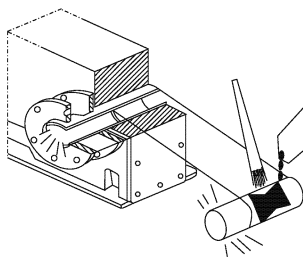

Pic.17

4. Rivet the shaft.

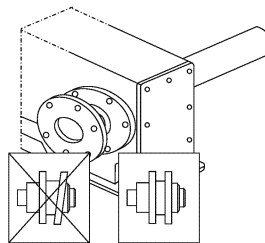

Pic.18



- 1) It is essential to make sure that the clamping area of the shrink disc is free from grease!
- 2) For this reason, never apply Anti-seize paste directly to the bushing as the paste may be able to get into the clamping area of the shrink disc when the input shaft is put on.

5. Tighten the locking bolts with the torque wrench by working round several times from one bolt to the next (not in diametrically opposite sequence)

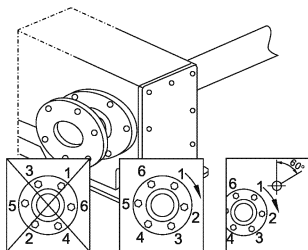

Pic.19

Table 4

Gear unit type	Bolt	Nm	←max. ¹⁾
JRTSH37..77	M5	5	60°
JRTKH87/97 FH37..77 SH47..77	M6	12	
JRTKH87/97 FH87/97 SH87	M8	30	
JRTKH107 FH107	M10	59	
JRTKH127/157 FH127	M12	100	
JRTKH167/187	M16	250	

1) Maximum tightening angle per cycle

Notes on removing the avoid shrink disk

1. Unscrew the locking bolts evenly one after the other. Each locking bolt may only be unscrewed by about one quarter turn in the initial cycle. This is in order to avoid tilting and jamming the locking collars. Do not fully unscrew the locking bolts!
2. Remove the shaft or pull the hub off the shaft. (You must first remove any rust that may have formed between the hub and the end of the shaft).
3. Pull the shrink disk off the hub.



Caution:
Risk of injury if the shrink disk is not removed correctly!

Cleaning and lubricating the shrink disk

There is no need to strip down and re-grease disassembled shrink disks before they are screwed back on.

The shrink disk only needs to be cleaned and re-greased if it is contaminated.

Use one of the following solid lubricants for the tapered surfaces:

Lubricant (Mo S2)	Sold as
Molykote321(Lube coat)	Spray
Molykote spray(powder spray)	Spray
Molykote G Rapid	Spray or paste
Aemasol MO 19P	Spray or paste
Aemasol	Spray
DIO—setral 57N(Lube coat)	

Grease the locking bolts with a multipurpose grease such as Molykote BR2 or similar.

4.4AM adapter coupling

IEC adapter AM63-225/NEMA adapter AM56-365

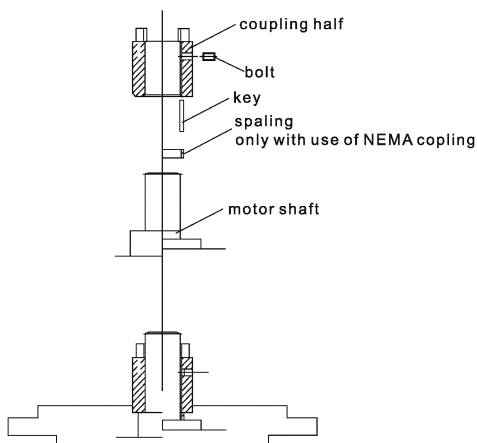

Pic.20

1. Clean the motor shaft and flange surfaces of the motor and adapter.
2. Remove the key from the motor shaft and replace it with the supplied key (not AM63 and AM250).
3. Heat the coupling half to approx 80° C ~ 100° C, push the coupling half onto the motor shaft.
4. Use a setscrew to secure the coupling half and the key on the motor shaft.
5. Install motor onto the adapter, making sure that the dogs of the two coupling halves engage in each other.



When installing a motor onto the adapter, you must use an anaerobic fluid seal to ensure that moisture cannot penetrate adapter.

*Advise to daub the lube in the coupling half, for preventing the osculant cant erization.

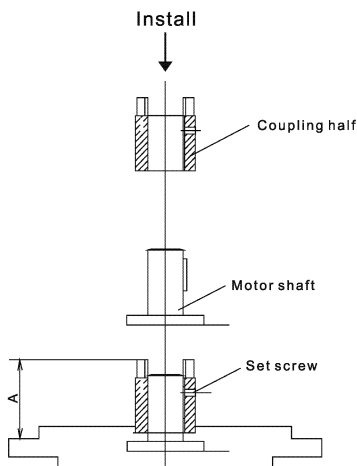
AM adapter coupling (IEC adapter coupling AM250/AM280)

Pic.21

1. Clean the motor shaft and flange surfaces of the motor and adapter.
2. Remove the key from the motor shaft and replace it with the supplied key (not AM63 and AM250).
3. Heat the coupling half(479)to approx 80° C~100° C, push the coupling half onto the motor shaft.
4. Check point A
5. Mount the motor on the adapter. When doing this, make sure the coupling dogs of the adapter shaft engage in the plastic spider.

4.5AQ adapter coupling

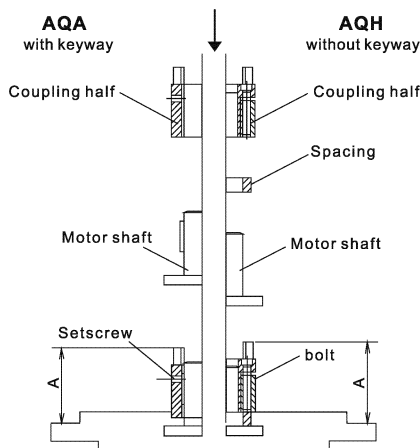

Pic.22

1. Clean the motor shaft and flange surfaces of the motor and adapter.
2. AQH: Unscrew the bolts of the coupling half and loosen the conical Connection.
3. Heat the coupling half ($80\sim 100^{\circ}\text{C}$) and push it onto the motor shaft. Type AQA/AQH: Up to clearance "A" (see table).
4. AQH: Tighten the bolts on the coupling half in diametrically opposite sequence until all bolts reach the tighten T_t , specified in the table.
AQA: Use a setscrew to secure the coupling half.
5. Check the position of the coupling half
Install motor onto the adapter making sure that the dogs of the two coupling halves engage in each other. The force that must be applied when joining the two coupling halves is dissipated after final assembly, so there is no risk of any axial load being applied to adjacent bearings.

Setting dimensions, tightening torque

Table.6: Coupling size, Tightening torque.

Type	Coupling size	Clearance "A" [mm]	Bolts DIN 912 ¹⁾	Tightening torque T_t [Nm]
AQA/AQH80/1/2/3	19/24	44.5	M4	3
AQA/AQH100/1/2		39		
AQA/AQH100/3/4		53		
AQA/AQH115/1/2/3		62		
AQA/AQH115/3	24/28	62	M5	6
AQA/AQH140/1/2	28/38	62	M5	6
AQA/AQH140/3		74.5		
AQA/AQH190/1/2		76.5		
AQA/AQH190/3	38/45	100	M6	10

1) Use in (AQH)

4.6 AD input shaft assembly

Please refer to Sec. "Installing input and output shafts" for information on mounting of input elements.

5 Startup

5.1 Startup of helical-worm gear units



Note: The direction of rotation of the output shaft JRTS..helical-worm gear units has been changed from CW to CCW; this is different from the S..2 series. Change direction of rotation: Swap over two motor feeder cables.

Run-in period

Helical-worm gear units require a run-in period of at least 24 hours before reaching their maximum efficiency. A separate run-in period applies for each direction of rotation if the gear unit is operated in both directions of rotation. The table show the average power reduction during the run-in period.

Table 7: Average losing power of helical -worm gear units.

No. of starts	Helical-worm gear units	
	Power reduction	i range
1	12%	50...280
2	6%	20...75
3	3%	20...90
4	-	-
5	3%	6...25
6	2%	7...25

6. Inspection and Maintenance

6.1 Inspection and maintenance intervals

table 8: Cycle of back-check and maintenance

Frequency	What to do ?	Memo
After 300 hours initial operating	cleanning house, then change oil	See 6.3
Every 3000 machine hours, at least every 6 mouths	Check oil and oil level	
Depending on the operating conditions(see pic 23)every 3 years at the latest	Change mineral oil	
	Replace anti-friction bearing grease Replace oil seal	
Depending on the operating conditions(see pic 23)every 5 years at the latest	Change synthetic oil	
	Replace anti-friction bearing grease Replace oil seal	
JRTR17/27 are have lubrication for life and are therefore maintenance-free		

6.2 Lubricant change intervals

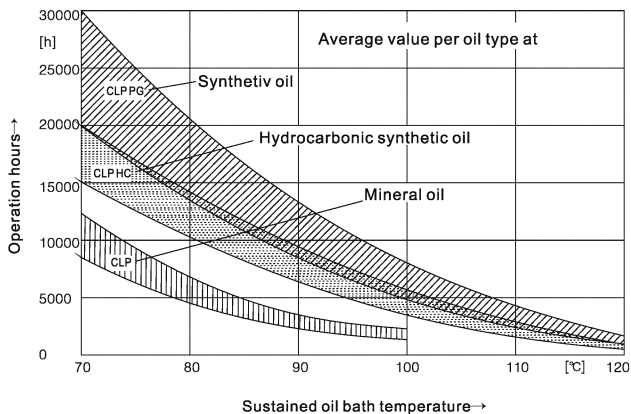

Pic.23 Oil change intervals for standard gear units under normal environmental conditions.

6.3 Inspection and maintenance of the gear unit

Do not intermix synthetic lubricants and do not mix synthetic and mineral lubricants together!

The position of the oil level and oil drain plug and the breather valve depends on the mounting position. Refer to the diagrams of the mounting positions.

Checking the oil level



1. De-energize the gearmotor and secure it to prevent it from being switched on inadvertently!

Wait until the gear unit has cooled off-Danger of burns!

2. Refer to Sec. "Installing the gear unit" when changing the mounting position!
3. For gear units with an oil level plug: Remove the oil level plug, check the fill level and correct it if necessary. Screw the oil level plug back in.

Checking the oil



1. De-energize the gearmotor and secure it to prevent it from being switched on inadvertently!

Wait until the gear unit has cooled off-Danger of burns!

2. Remove a little oil from the oil drain plug.
3. Check the oil consistency.
4. For gear units with an oil level plug: Remove the oil level plug, check the fill level and correct it if necessary. Screw the oil level plug back in.

Changing the oil Only change the oil when the gear unit is at operating temperature.



1. **De-energize the gearmotor and secure it to prevent it from being switched on inadvertently!**
Wait until the gear unit has cooled off-Danger of burns!
Note: The gear unit must still be warm otherwise the high viscosity of excessively cold oil will make it harder to drain the oil correctly.
2. Place a container underneath the oil drain plug
3. Remove the oil level plug, breather plug/breather valve and oil drain plug.
4. Drain all the oil.
5. Screw in the oil drain plug.
6. Pour in new oil of the same type through the vent hole. Do not mix synthetic Lubricants.
 - Pour in the volume of oil in accordance with the mounting position or as specified on the nameplate.
 - Check at the oil level plug.
7. Screw the oil level plug and the breather plug back in

7 Malfunctions

Problem	Possible cause	Remedy
Unusual, regular running noise	a) Meshing/grinding noise: Bearing damage b) Knocking noise: irregularity in the gearing	1. Check the oil, change bearings Contact customer service
Unusual, irregular Running noise	Foreign bodies in the oil	1. Check the oil Stop the drive, contact customer service
Oil leaking ¹⁾ <ul style="list-style-type: none"> • From the gear cover plate • From the motor flange • From the output end oil seal • From the motor oil seal 	a) Rubber seal on the gear cover plate leaking b) Seal defective c) Gear unit not vented	a). Tighten the bolts on the gear cover plate and observe the gear unit, Oil still leaking: Contact customer service b). Contact customer service
Oil leaking from breather valve	a) Too much oil b) Drive operated in incorrect mounting position c) Frequent cold starts (oil foams) and/or high oil level	a) Correct the oil level b) Mount the breather valve correctly and correct the oil level
Output shaft does not turn Although the motor is run-Ming or the input shaft is rotated	Connection between shaft and hub in gear unit interrupted	Send in the gear unit/ gearmotor for repair

- 1) Short-term oil/grease leakage at the oil seal is possible in the run-in phase (24 hours running time).

Please have the following information to hand if you require the assistance of our customer service:

- Data from the nameplate (complete)
- Nature and extent of the fault
- Time and peripheral circumstances of the fault
- Presumed cause

8 Mounting Positions

8.1 General information on mounting positions

Mounting position designation
 JIE differentiates between six mounting position M1~M6 for gear units. The following figure shows the gearmotor in mounting positions M1~M6.

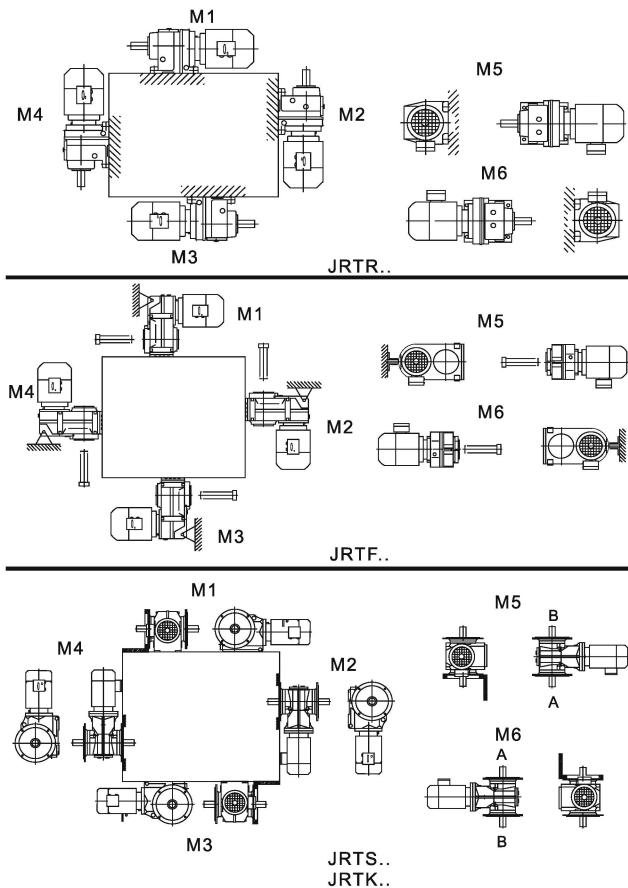

Pic.24 Depiction of mounting positions M1~M6

Remark:1. Bolt with rubber band is breather valve.

2. The read bolt is oil level plug.

3. The downmost bolt is oil drain plug.

8.2 Important order information

Position of the Motor terminal box and cable entry

Possible positions of the terminal box are 0° , 90° , 180° , 270° .

As viewed onto and cable entry the fanguard.

In addition, the position of the cable entry can be selected. The possibilities are "X" (normal position), "1", "2" or "3"

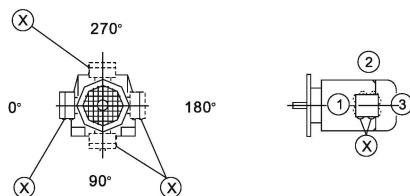

Pic.25 Position of terminal box and out line plug.

The terminal box cannot be positioned at 90° on the R17d63... geared motor.

- Only: cable entries "X" and "2" are possible with DT56 and DR63 motor
- Exception : This restriction does not apply to the D63 with the Isplug connector.
- Cable entry "2" is not possible with the D71..BMG 90° motor with terminal. Box position 90° .

Position of the Output shaft and the output flange

In right-angle gear units, it is necessary to indicate the position of the output shaft and output flange:

A or B or A+B

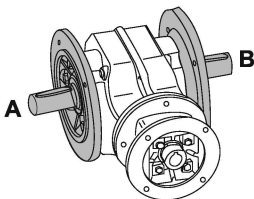

Pic. 26 Position of output shaft and output flange.

Position of the Connection end in Right-angle gear units

In shaft mounted right-angle gear units with shrink disk, it is necessary to indicate whether the A or B end is the connection end. In Fig 12, the A end is the connection end. The shrink disk is located opposite the connection end.

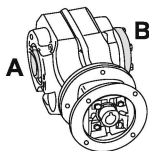

Pic. 27 Position of joint

Connection end at bottom only is possible with JRTK167/JRTK187, in mounting Positions M5 and M6.

Table 9: Example

Type	Mtg. Pos.	Shaft with	Flange with	Connection end	Position of shrink disk	Position of Terminal box	Position of cable entry	Dir. Of rot. Of the output
JRTK47D71D4	M2	A	-	-	-	0°	"X"	CW
JRTSF77D100L4	M6	A+B	A+B	-	-	90°	"3"	-
JRTKA97D132M4	M4	-	-	B	-	270°	"2"	-
JRTKH107D160L4	M1	-	-	A	B	180°	"3"	-

Symbols used

The following table shows the symbols used in the mounting position sheets and what they mean:

Table. 10

Symbol	Meaning
	Breather valve
	Oil level plug
	Oil drain plug
	In line plug

Churning losses

Increased churning losses may arise in some mounting positions. Please contact JIE in case of the following combinations:

Table 11

Mounting position	Gear unit type	Gear unit size	Input speed (rpm)
M2,M4	JRTR	97...107	>2500
		>107	>1500
M2,M3,M4,M5,M6	JRTF	97...107	>2500
		>107	>1500
	JRTR	77...107	>2500
		>107	>1500
	JRTR	77...97	>2500
		>97	>1500

9 Lubricants

9.1 Lubricant fill quantities

The specified fill quantities are recommended values. The precise values vary depending on the number of stages and gear ratio. When filling, it is essential to check the oil level plug since it indicates the precise oil capacity.

The following tables show guide values for lubricant fill quantities in relation to the Mounting position M1~M6.

Helical gear units

(JRTR)

Gear unit type	Fill quantity (L)					
	M1 ¹⁾	M2 ¹⁾	M3	M4	M5	M6
JRTR17/R17F	0.25	0.6	0.35	0.6	0.35	0.35
JRTR27/R27F	0.25/0.4	0.7	0.4	0.7	0.4	0.4
JRTR37/R37F	0.3/1	0.9	1	1.1	0.8	1
JRTR47/R47F	0.7/1.5	1.6	1.5	1.7	1.5	1.5
JRTR57/R57F	0.8/1.7	1.9	1.7	2.1	1.7	1.7
JRTR67/R67F	1.1/2.3	2.6/3.5	2.8	3.2	1.8	2
JRTR77/R77F	1.2/3	3.8/4.3	3.6	4.3	2.5	3.4
JRTR87/R87F	2.3/6	6.7/8.4	7.2	7.7	6.3	6.5
JRTR97	4.6/9.8	11.7/14	11.7	13.4	11.3	11.7
JRTR107	6/13.7	16.3	16.9	19.2	13.2	15.9
JRTR137	10/25	28	29.5	31.5	25	25
JRTR147	15.4/40	46.5	48	52	39.5	41
JRTR167	27/70	82	78	88	66	69

Gear unit type	Fill quantity (L)					
	M1 ¹⁾	M2 ¹⁾	M3	M4	M5	M6
JRTRF17	0.25	0.6	0.35	0.6	0.35	0.35
JRTRF27	0.25/0.4	0.7	0.4	0.7	0.4	0.4
JRTRF37	0.4/1	0.9	1	1.1	0.8	1
JRTRF47	0.7/1.5	1.6	1.5	1.7	1.5	1.5
JRTRF57	0.8/1.7	1.8	1.7	2.1	1.7	1.7
JRTRF67	1.2/2.5	2.7/3.6	2.7	3.1	1.9	2.1
JRTRF77	1.2/2.6	3.8/4.1	3.3	4.1	2.4	3
JRTRF87	2.4/6	6.8/7.9	7.1	7.7	6.3	6.4
JRTRF97	5.1/10.2	11.9/14	11.2	14	11.2	11.8
JRTRF107	6.3/14.9	15.9	17	19.2	13.1	15.9
JRTRF137	9.5/25	27	29	32.5	25	25
JRTRF147	16.4/42	47	48	52	42	42
JRTRF167	26/70	82	78	88	66	71

1)The output end gear unit of multi-stage gear units must be filled with the larger oil volume.

Gear unit type	Fill quantity (L)					
	M1	M2	M3	M4	M5	M6
JRTRX57	0.6	0.8	1.3	1.3	0.9	0.9
JRTRX67	0.8	0.8	1.7	1.9	1.1	1.1
JRTRX77	1.1	1.5	2.6	2.7	1.6	1.6
JRTRX87	1.7	2.5	4.8	4.8	2.9	2.9
JRTRX97	2.1	3.4	7.4	7	4.8	4.8
JRTRX107	3.9	5.6	11.6	11.9	7.7	7.7

Gear unit type	Fill quantity (L)					
	M1	M2	M3	M4	M5	M6
JRTRXF57	0.5	0.8	1.1	1.1	0.7	0.7
JRTRXF67	0.7	0.8	1.5	1.7	1	1
JRTRXF77	0.9	1.5	2.4	2.5	1.6	1.6
JRTRXF87	1.6	2.5	4.9	4.7	2.9	2.9
JRTRXF97	2.1	3.6	7.1	7	4.8	4.8
JRTRXF107	3.1	5.9	11.2	10.5	7.2	7.2

Parallel shaft helical gear units (JRTF)

JRTF..JRTFA..B,JRTFH..B,JRTFV..B:

Gear unit type	Fill quantity (L)					
	M1	M2	M3	M4	M5	M6
JRTF..37	1	1.2	0.7	1.2	1	1.1
JRTF..47	1.5	1.8	1.1	1.9	1.5	1.7
JRTF..57	2.6	3.7	2.1	3.5	2.8	2.9
JRTF..67	2.7	3.8	1.9	3.8	2.9	3.2
JRTF..77	5	7.3	4.3	8	6	6.3
JRTF..87	11	13.0	7.7	13.8	10.8	11
JRTF..97	18.5	22.5	12.6	25.2	18.5	20
JRTF..107	24.5	32	19.5	37.5	27	27
JRTF..127	40.5	55	34	61	46.5	47
JRTF..157	69	104	63	105	86	78

JRTFF..:

Gear unit type	Fill quantity (L)					
	M1	M2	M3	M4	M5	M6
JRTFF..37	1	1.2	0.7	1.3	1	1.1
JRTFF..47	1.5	1.9	1.1	1.9	1.5	1.7
JRTFF..57	2.6	3.8	2.1	3.7	2.9	3
JRTFF..67	2.7	3.8	1.9	3.8	2.9	3.2
JRTFF..77	5.1	7.3	4.3	8.1	6	6.3
JRTFF..87	10.3	13.2	7.8	14.4	11	11.2
JRTFF..97	19	22.5	12.6	25.5	18.9	20.5
JRTFF..107	25.5	32	19.5	38.5	27.5	28
JRTFF..127	41.5	56	34	63	46.5	49
JRTFF..157	72	105	64	106	87	79

**JRTFA...,JRTFH...,JRTFV...,JRTFAF...,JRTFHF...,JRTFVF...,JRTFAZ...,
JRTFHZ...,JRTFVZ...:**

Gear unit type	Fill quantity (L)					
	M1	M2	M3	M4	M5	M6
JRTF..37	1	1.2	0.7	1.2	1	1.1
JRTF..47	1.5	1.8	1.1	1.9	1.5	1.7
JRTF..57	2.7	3.8	2.1	3.6	2.9	3
JRTF..67	2.7	3.8	1.9	3.8	2.9	3.2
JRTF..77	5	7.3	4.3	8	6	6.3
JRTF..87	10	13.0	7.7	13.8	10.8	11
JRTF..97	18.5	22.5	12.6	25.0	18.5	20
JRTF..107	24.5	32	19.5	37.5	27	27
JRTF..127	39	55	34	61	45	46.5
JRTF..157	68	103	62	104	85	77

**JRTFA...,JRTFH...,JRTFV...,JRTFAF...,JRTFHF...,JRTFVF...,JRTFAZ...,
JRTFHZ...,JRTFVZ...:**

JRTK...,JRTKA..B,JRTKH..B,JRTKV..B:

Gear unit type	Fill quantity (L)					
	M1	M2	M3	M4	M5	M6
JRTK..37	0.5	1	1	1.3	1	1
JRTK..47	0.8	1.3	1.5	2	1.6	1.6
JRTK..57	1.2	2.3	2.5	3	2.6	2.4
JRTK..67	1.1	2.4	2.6	3.4	2.6	2.6
JRTK..77	2.2	4.1	4.4	5.9	4.2	4.4
JRTK..87	3.7	8	8.7	10.9	7.8	8
JRTK..97	7	14	15.7	20	15.7	15.5
JRTK..107	10	21	25.5	33.5	24	24
JRTK..127	21	41.5	44	54	40	41
JRTK..157	31	62	65	90	58	62
JRTK..167	35	100	100	125	85	85
JRTK..187	60	170	170	205	130	130

JRTKF..:

Gear unit type	Fill quantity (L)					
	M1	M2	M3	M4	M5	M6
JRTKF37	0.5	1.1	1.1	1.5	1	1
JRTKF47	0.8	1.3	1.7	2.2	1.6	1.6
JRTKF57	1.3	2.3	2.7	3	2.9	2.7
JRTKF67	1.1	2.4	2.8	3.6	2.7	2.7
JRTKF77	2.1	4.1	4.4	6	4.5	4.5
JRTKF87	3.7	8.2	9	11.9	8.4	8.4
JRTKF97	7	14.7	17.3	21.5	15.7	16.5
JRTKF107	10	22	26	35	25	25
JRTKF127	21	41.5	46	55	41	41
JRTKF157	31	66	69	92	62	62

**JRTKA...,JRTKH...,JRTKV...,JRTKAF...,JRTKHF...,JRTKVF...,JRTKAZ...,
JRTKHZ...,JRTKVZ...:**

Gear unit type	Fill quantity (L)					
	M1	M2	M3	M4	M5	M6
JRTK..37	0.5	1	1	1.4	1	1
JRTK..47	0.8	1.3	1.6	2.1	1.6	1.6
JRTK..57	1.3	2.3	2.7	3	2.9	2.7
JRTK..67	1.1	2.4	2.7	3.6	2.6	2.6
JRTK..77	2.1	4.1	4.6	6	4.4	4.4
JRTK..87	3.7	8.2	8.8	11.1	8	8
JRTK..97	7	14.7	15.7	20	15.7	15.7
JRTK..107	10	20.5	24	32	24	24
JRTK..127	21	41.5	43	52	40	40
JRTK..157	31	66	67	87	62	62
JRTKH167	35	100	100	125	85	85
JRTKH187	60	170	170	205	130	130

**Helical-worm gear units
(JRTS)**
JRTS...:

Gear unit type	Fill quantity (L)					
	M1	M2	M3 ¹⁾	M4	M5	M6
JRTS37	0.25	0.4	0.5	0.6	0.4	0.4
JRTS47	0.35	0.8	0.7	1.1	0.8	0.8
JRTS57	0.5	1.2	1	1.5	1.3	1.3
JRTS67	1	2.0	2.2/3.1	3.2	2.6	2.6
JRTS77	1.9	4.2	3.7/5.4	6	4.4	4.4
JRTS87	3.3	8.1	6.9/10.4	12	8.4	8.4
JRTS97	6.8	15	13.4/18	22.5	17	17

JRTSF..:

Gear unit type	Fill quantity (L)					
	M1	M2	M3 ¹⁾	M4	M5	M6
JRTSF37	0.25	0.4	0.5	0.6	0.4	0.4
JRTSF47	0.4	0.9	0.9	1.2	1.0	1.0
JRTSF57	0.5	1.2	1	1.6	1.4	1.4
JRTSF67	1	2.2	2.3/3	3.2	2.7	2.7
JRTSF77	1.9	4.1	3.9/5.8	6.5	4.9	4.9
JRTSF87	3.8	8	7.1/10.1	12	9.1	9.1
JRTSF97	7.4	15	13.8/18.8	23.6	18	18

JRTSA...,JRTSH...,JRTSAF...,JRTSHF...,JRTSAZ...,JRTSHZ...:

Gear unit type	Fill quantity (L)					
	M1	M2	M3 ¹⁾	M4	M5	M6
JRTS..37	0.25	0.4	0.5	0.6	0.4	0.4
JRTS..47	0.4	0.8	0.7	1.1	0.8	0.8
JRTS..57	0.5	1.1	1	1.6	1.2	1.2
JRTS..67	1	2	1.8/2.6	2.9	2.5	2.5
JRTS..77	1.8	3.9	3.6/5	5.9	4.5	4.5
JRTS..87	3.8	7.4	6/8.7	11.2	8	8
JRTS..97	7	14	11.4/16	21	15.7	15.7

















The output end gear unit of multi-stage gear units must be filled with the larger oil volume.

9.2 Lubricant used regularly

JRTR/JRTF/JRTK Mobil ISO VG220

JRTS Mobil ISO VG680

Other needs, please contact JIE.

<p>JRT GEAR UNITS & GEARMOTORS</p>	 <p>JRTR Helical Inline Gearmotors Size:17-187 Ratio:3.37-289.74 Input power:0.12-250kW Output torque:2.4-56494Nm</p>	 <p>JRTF Parallel Shaft-Helical Gearmotors Size:37-167 Ratio:3.77-281.71 Input power:0.12-250kW Output torque:3.5-37125Nm</p>
<p>JRH INDUSTRIAL GEAR UNITS</p>	 <p>JRH Parallel Shaft Gear Units Size:3-28 Ratio:1.25-450 Input power:4.3-10515kW Output torque:2300-1400000Nm</p>	 <p>JRH Helical-Bevel Gear Units Size:4-28 Ratio:5-400 Input power:2.8-4908kW Output torque:5500-1400000Nm</p>
<p>JRP PLANETARY GEAR UNITS</p>	 <p>JRP Planetary Gear Units Size:9-36 Ratio:25-4000 Input power:0.4-12934kW Output torque:22000-2600000Nm</p>	 <p>JRP Planetary Gear Units Size: 01-8 Ratio:3.08-3460 Input power:0.02-192kW Output torque:1000-13000Nm</p>
<p>JRW WORM GEAR UNITS</p>	 <p>JRW Worm Gears Size:30-150 Ratio:7.5-100 Input power:0.1-25.8kW Output torque:13-1550Nm</p>	 <p>JRW Worm Gears Size:25-150 Ratio:7.5-100 Input power:0.06-15kW Output torque:2.6-1760Nm</p>
<p>JD THREE PHASE ASYNCHRONOUS MOTORS</p>	 <p>JD IEC Standard Motors Size:63-315 Power:0.12-200kW Efficiency: IE2 , IE3 , IE4 (0.75-200kW)</p>	 <p>JDP Motors Size:63-315 Power:0.12-200kW Efficiency: IE2 , IE3 , IE4 (0.75-200kW)</p>
<p>JC INTELLIGENT DRIVE SOLUTIONS</p>	 <p>JC Intelligent Drive Solutions Industrial Drive Solutions incl Reducers, Motors, Converters, Sensors, Internet of Things, etc.</p>	 <p>JCI Intelligent Monitoring System Monitoring Items: Vibration, Temperature, Humidity, Air Pressure, Voltage, Current, geographical location, etc.</p>
<p>OPTIONAL DRIVES</p>	 <p>JRESR Stainless Steel Helical Gearmotors Size:37-67 Ratio:3.41-199.81 Input power:0.18-7.5kW Output torque: 26-670Nm</p>	 <p>JRESK Stainless Steel Helical-Bevel Gearmotors Size:37-67 Ratio:3.98-145.14 Input power:0.18-5.5kW Output torque:12-910Nm</p>
	 <p>JRGC Transfer Case Size:0401, 11501 Ratio:0.589, 0.859, 0.756, 0.825 Max Output Torque (Pump):1390Nm Max Output Torque (Working Shift) :4000Nm</p>	 <p>JTA Shaft Mounted Gear Units Size: 80/90-100/120 Ratio: 5-31.5 Power: 11-45kW Torque: 6600-10500Nm</p>

	<p>JRTK Helical-Bevel Gearmotors Size:37-187 Ratio:3.98-197.37 Input power:0.12-200kW Output torque:10-62800Nm</p>		<p>JRTS Helical-Worm Gearmotors Size:37-97 Ratio:6.8-288 Input power:0.12-22kW Output torque:10-4900Nm</p>		<p>JRTRX Gearmotors Size:57-107 Ratio:1.3-8.65 Input power:0.12-45kW Output torque:1.4-990Nm</p>
	<p>JRHD Bucket Elevator Gear Units Size:5-16 Ratio:25-71 Input power:16-1305kW Output torque: 11000-173000Nm</p>		<p>JRHO Palm Oil Gear Units Size: 310 Ratio:56, 80 Input power:106, 141kW Output torque:75000Nm</p>		<p>JRHA Air-Cooled Gear Units Size:166 Ratio:14 Input power:228kW Output torque:21000Nm</p>
	<p>JRPB Planetary Gear Units Size: 08-100 Ratio: 3.4-2000 Input power:75-250kW Output torque: 8000-100000Nm</p>		<p>VR Coaxial Planetary Gear Units Ratio: 3-100 Backlash: 1-3/3-5/5-7/3arc-min Torque: 6-3300Nm</p>		<p>EV Bevel Helical Gear Units Ratio: 3-100 Backlash: 4-9/6-11arc-min Torque: 12-1920Nm</p>
	<p>JRWND NEMA Size:30-150 Ratio:7.5-100 Input power:0.06-15kW Output torque:2.6-1760Nm</p>		<p>WPA Worm Gears Size:40-250 Ratio:10-60 Input power:0.12-33.2kW Output torque:19-2745Nm</p>		<p>WPW Worm Gears Size: 40-250 Ratio: 10-60 Backlash: 0.12-33.2kW Torque: 6-3025Nm</p>
	<p>JDN NEMA Standard Motors Size: 63-180 Power:0.12-22kW Efficiency: IE2, IE3, IE4</p>		<p>JDB Explosion-Proof Motors Size 80-315 Power:0.75-200kW Explosive-Proof Grade: Exib II BT4 Efficiency:IE2 , IE3</p>		<p>JDC Servo Motors Size: 30-90 Power: 0.4-7.5kW Rated torque: 1.27-48Nm</p>
	<p>JCM Converter & Gearmotor Integrated System Size:004-0075 Power:0.4-7.5kW Ingress Protection: IP54-IP65 Input Power: 3AC380-440V Output Frequency: 0-200Hz</p>		<p>JCF Frequency Converters Size: 0075-0550 Power: 0.75-55 kW Output Frequency: 0-200Hz Carrier Frequency: 8-32kHz</p>		<p>JCS Servo Drivers Size: FSA/F5B/F5C Power: 0.4-7.5kW Input Power: 1AC 22V/3AC 380V</p>
	<p>JRSS Stainless Steel Worm Gears Size:40-90 Ratio:7.5-100 Input power:0.09-4kW Output torque:19-458Nm</p>		<p>JRSL Screw Lifter Size: 35-150 Ratio:5-40 Input power:0.19-16.3kW Lift Capacity: 500-26050Kg</p>		<p>JRSM Spiral Bevel Right Angle Size:2-25 Ratio:1-5 Input power:0.014-335kW Input speed: 10-1450r/min</p>
	<p>JEC Escalator Reducer Size:2-15, 2-25 Ratio:24.5 Efficiency:≥96% Working lift:146000h Output torque: 3530-5150Nm</p>		<p>JN Agricultural Machinery Gear Units Ratio:0.364-2.33 Input speed:800r/min Efficiency:≥96%</p>		<p>JIE Intelligent Drive Solution Provider For more products, please contact JIE.</p> <p>JIE Drive Product Catalogue</p>



JIE Website



JIE USA



JIE Intelligent Drive Industrial Zone



Intelligent Plant of Supply Chain



Intelligent Plant of Gear Units Housing



Intelligent Plant of Gears



Intelligent Plant of Motors



Intelligent Plant of Gear Units Assembling

Established in 1988, JIE has been insisting on manufacturing a great reducer in 100 years, aiming to build a century-old enterprise with its craftsmanship.

JIE serves global market with intelligent drive solutions incl. gear units, motors, inverters, sensors and Internet of Things. JIE is committed to providing great products for great partners across the world.

With the core strategy of "Specialization, Intelligence and Globalization", JIE is dedicated to the innovation and application of industry 4.0 technologies incl. intelligent plants, intelligent products, intelligent services, intelligent experiences, intelligent talents, etc.

JIE, a provider of Intelligent Drive Solutions!



HANGZHOU JIE DRIVE TECHNOLOGY CO.,LTD.

Address : No.1, JIE Road, Hangzhou Airport Economic Zone, Xiaoshan, 311223, Hangzhou, P.R. China

Tel : +86 571 8299 1111 400 114 1111

Call Center : +86 571 8299 2222

Fax : +86 571 8299 3333

E-mail : jie@jie.com.cn

Web : www.jie.com.cn www.jiedrive.com

JIE USA, INC.

Address : 493 Mission St. Carol Stream IL 60188 USA

Tel : +1 630 580 9986

E-mail : info@jie-drives.com

Web : www.jie-drives.com